

Technical Data Information

Product Code: UHT327

Information: Colour/Finish: Chrome
Nett Wt. Kg: 0.82

Overall Dimensions: H: 80 x D: 70 x W: 26

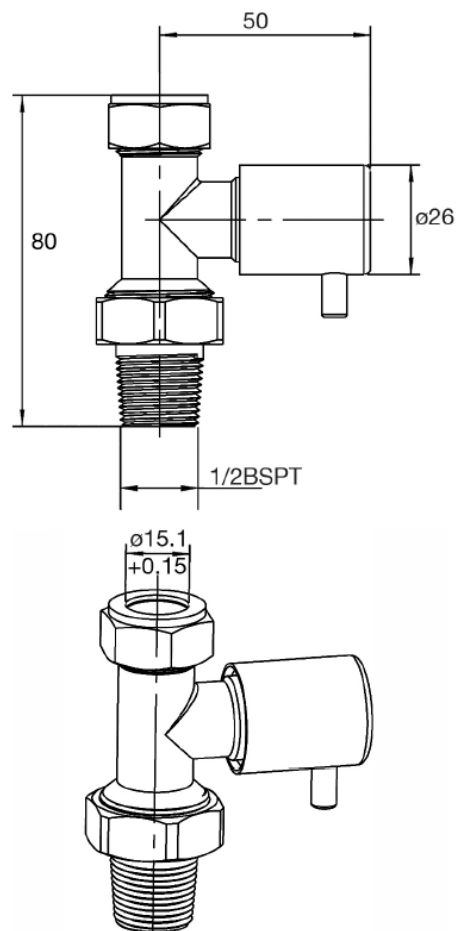

All Dimensions are in millimetres. The information contained on this page was correct at date of issue. Fitting dimensions are provided as a guide only. Some variation may occur due to manufacturing tolerances. We pursue a policy of continuing improvement in design and performance of our products and so reserve the right to change specifications without prior notice.