

Technical Data Information

Product Code:	UALA305
Information:	Alpha Mono Basin Low Pressure Tap
Construction	Brass Body (CuZn38Pb18)
Finishes	Chrome plated to BS EN 248
Product Type	Contemporary
Water Pressure	Min. 0.2 bar, Max. 6.0 bar
Plumbing Systems	Suitable for all plumbing systems
Standards	Complies with BS5412, BS EN200
Certification	Manufactured to comply with WRAS
Cartridge	40mm ceramic disc cartridge
Fitting	M12 x 350mm ½" BSP Female Flexi Tails
Packaging	31x27.5x34.5cm / carton (10 boxes / carton)
Guarantee	10 years against manufacturing faults (excluding serviceable parts).
Additional Information	Supplied with G 1¼" sprung waste

Overall Dimensions: H: 120 x D: 125 x W: 45

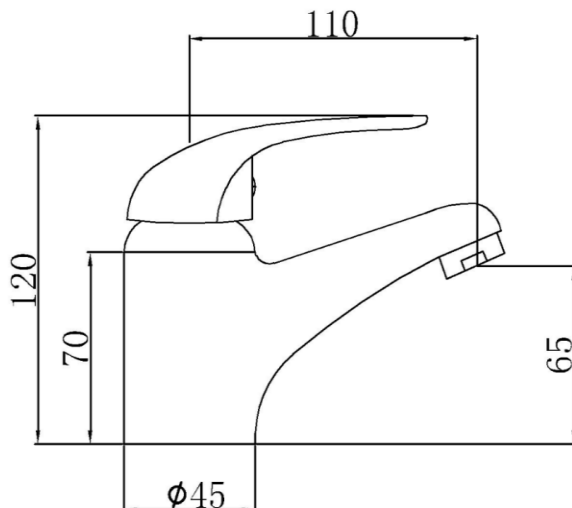

All Dimensions are in millimetres. The information contained on this page was correct at date of issue. Fitting dimensions are provided as a guide only. Some variation may occur due to manufacturing tolerances. We pursue a policy of continuing improvement in design and performance of our products and so reserve the right to change specifications without prior notice.